

# Blend

B85 HEALTH BLENDER USER GUIDE

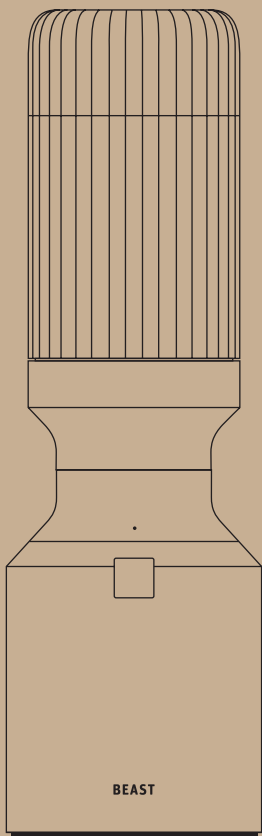

**BEAST.**<sup>®</sup>

**THIS BOOK COVERS MODEL: B85**

Voltage: 120 VAC

Frequency: 60 Hz

Wattage: Max. 850 W

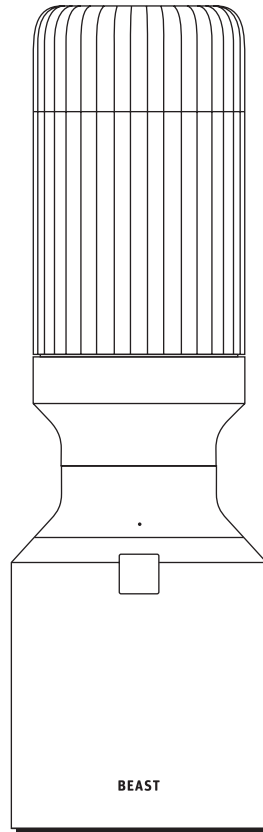

**BEAST®**

## **Meet Beast.**

We've always known we were supposed to eat our vegetables.

We've always known we were supposed to drink lots of water.

But didn't...

So we set out to create a blending system that would make Mom proud.

Beast fuels your body with real food: no processing, no additives, no BS.

From energy-boosting morning blends, to performance fueling smoothies throughout the day, and blended desserts in the evening, Beast fits seamlessly into your life to make you...

**strong inside™**

## Contents

Important Safeguards.....	5-8
What's Included.....	9
Before Use.....	10
B85 Blender Light Indicators.....	11-12
How to Use Your B85 Blender.....	13-16
Vessel Fill Example Chart.....	17
Tips & Tricks.....	18-19
Troubleshooting.....	19-20
Beast Mighty Blade.....	21
Care & Cleaning.....	22-23
Warranty.....	24-25

## ▲ IMPORTANT SAFEGUARDS

**READ ALL INSTRUCTIONS AND IMPORTANT SAFEGUARDS TO AVOID THE RISK OF SERIOUS INJURY.**

### **FOR HOUSEHOLD USE ONLY**

**WHEN USING ELECTRICAL APPLIANCES, ALWAYS FOLLOW BASIC SAFETY PRECAUTIONS, INCLUDING THE FOLLOWING:**

- To reduce the risk of electric shock, the BEAST® MIGHTY BLENDER has a polarized plug (one prong is wider than the other). This plug will fit into a polarized outlet only one way. If the plug does not fit fully into the outlet, reverse the plug. If it still does not fit, contact a qualified electrician to install the proper outlet. **DO NOT** modify the plug in any way.
- To protect against the risk of electrical shock, do not put cord, plug, or base in water or any other liquid.
- Extension cords are not recommended for use with this product.
- **DO NOT** abuse the power cord. Never carry the appliance by the power cord or pull on it to disconnect from the electrical outlet. Instead, grasp the plug itself and pull to disconnect.
- **DO NOT** operate the BEAST® MIGHTY BLENDER with a damaged cord or plug, or after it has been dropped or damaged in any manner. The BEAST® MIGHTY BLENDER has no serviceable parts. Email customerservice@thebeast.com if you have any questions or concerns.
- **DO NOT** let the power cord hang over the edge of a counter or touch hot surfaces, such as the stove top. Do not place near a hot gas or electric burner.

**TO REDUCE THE RISK OF FIRE, ELECTRIC SHOCK, OR PERSONAL INJURY AND/OR PROPERTY DAMAGE:**

- **BLADES ARE SHARP! HANDLE WITH CARE.** To avoid injury, do not handle or touch any blade edge. Use caution and grasp by the Mighty Blade.
- To protect against electrical shock, do not submerge the appliance or allow the power cord or Blender Base to come into contact with water or liquids.
- The BEAST® MIGHTY BLENDER has moving parts. Avoid contact with moving parts. Keep fingers out of the container and away from the blades.
- To reduce the risk of injury, **NEVER** operate the BEAST® MIGHTY BLENDER without the vessel properly assembled to the blade housing. **DO NOT** try to defeat the interlock mechanism. Ensure that the vessel is properly installed before operating the appliance.

## ▲ IMPORTANT SAFEGUARDS

- Keep hands, hair, clothing, and utensils out of the vessel while powered on to reduce the risk of severe injury to persons and damage to the BEAST® MIGHTY BLENDER. You may use a scraper, or the Beast Vessel Spatula (not included), but only when the appliance is not running.
- **DO NOT** operate the BEAST® MIGHTY BLENDER with a damaged Mighty Blade, if it malfunctions, or has been dropped or damaged in any manner. The BEAST® MIGHTY BLENDER Mighty Blade has no serviceable parts. Return the appliance to BEAST HEALTH, LLC for examination, replacement, and/or adjustment.
- To reduce the risk of injury, never place the Mighty Blade on the base without the Blending Vessel properly attached. Always wait until the motor has stopped completely before removing the Blending Vessel.
- Remember to **TURN THE POWER SWITCH OFF** when the BEAST® MIGHTY BLENDER is not in use, before assembling or disassembling parts, and before cleaning. You will know that it has successfully turned off when the light goes out. To unplug the BEAST® MIGHTY BLENDER, grasp the plug and pull from the electrical outlet. Never pull from the power cord.
- **DO NOT** remove the Blending Vessel from the Blender Base while it is operating. Wait until the motor powers down completely, the blades stop spinning, and the ingredients settle to remove the vessel and then **POWER OFF**.
- **NEVER BLEND HOT INGREDIENTS.** Doing so may cause excessive steam and pressure to build up in the vessel, resulting in the potential risk of the vessel and blender base separating and thereby possibly resulting in personal injury and/or property damage.
- Never operate the unit for longer than one minute. Blade friction for prolonged periods can cause heat and related pressure buildup in a closed vessel, with the danger of personal injury and/or property damage.
- Ensure the ventilation holes on the rear of the blender base are kept clean and never obstructed.
- **NEVER BLEND CARBONATED INGREDIENTS, INCLUDING LIQUIDS, OR RISING LEAVENING AGENTS IN THE BEAST® MIGHTY BLENDER.** These ingredients release or produce air bubbles that can produce foam and cause contents in the Blending Vessel to expand. Blending these ingredients may cause

**IMPORTANT SAFEGUARDS CONTINUE ON NEXT PAGE**

## ▲ IMPORTANT SAFEGUARDS

excessive pressure buildup in the container and may cause personal injury to the user or property damage. Common leavening agents such as baking powder, baking soda, cream of tartar, cultured or fermented ingredients, egg whites, egg white protein powder, salt of hartshorn (ammonium carbonate), whey protein, sea moss, or yeast should not be blended in the BEAST® MIGHTY BLENDER.

- **NEVER** store ingredients in the Blending Vessel with the Mighty Blade attached, both before and after blending. Some foods may contain active ingredients or release gases that will expand in the container. If the ingredients are left in the sealed container, excessive pressure can build up through natural fermentation or chemical interactions and pose a risk of personal injury. To safely store ingredients in the container, first remove the lid to allow the blend to rest for a few minutes and allow excess gases to escape. Then use the Storage Lid to cover and store in the refrigerator, which will release any built-up gases daily.
- If these warnings are not adhered to, as mentioned, pressure can build up in the Blending Vessel and cause the Vessel and Mighty Blade to separate or blended contents to erupt from the container, resulting in possible personal injury and/or property damage. If the sealed Blending Vessel is warm to the touch, power off your machine and allow the Vessel to cool for fifteen minutes or more. Allow contents to settle before slowly releasing the Vessel from the Mighty Blade. With the Blending Vessel pointed away from your face and body, slowly unscrew the Mighty Blade to gently release any residual pressure. If you are unable to unscrew the Mighty Blade from the Blending Vessel, we recommend that you purchase and use your Beast Wrench to dislodge and/or unscrew the Vessel from the Mighty Blade. Purchase at [thebeast.com](http://thebeast.com). Further tips and tricks can be found on Page 18-19.
- The BEAST® MIGHTY BLENDER should not be used to grind hard spices or beans, as this may cause damage to the blades and/or blending vessels.
- This appliance is not intended for use by persons (including children) with reduced physical, sensory, or mental capabilities, or lack of experience and knowledge, unless they are closely supervised and instructed concerning use of the appliance by a person responsible for their safety. Close supervision is necessary when any appliance is used by or near children. Children should be supervised to ensure that they do not play with the appliance.

## ▲ IMPORTANT SAFEGUARDS

- Do not use your BEAST® MIGHTY BLENDER under the influence of drugs or alcohol.
- **NEVER** leave the BEAST® MIGHTY BLENDER unattended while in use or when children or present.
- BEAST® accessories are not intended to be used in the microwave, which may result in damage to the accessories or microwave.
- **ALWAYS** use the BEAST® MIGHTY BLENDER on a dry, stable, level surface.
- **DO NOT** use the BEAST® MIGHTY BLENDER within 12 inches of the edge of any work surface or counter.
- **DO NOT** operate the BEAST® MIGHTY BLENDER on or near any hot surfaces (such as a gas or electric burner or in a heated oven).
- **DO NOT** use attachments or accessories (including canning jars) not recommended or sold by the manufacturer with the BEAST® MIGHTY BLENDER. Use of these items may result in fire, electric shock, or personal injury. Such misuse may also void the warranty.
- **DO NOT overfill the Blending Vessel. Fill only to the MAX line, as ingredients need space to ensure complete and thorough blending and to avoid damaging the motor.**
- **DO NOT** operate the BEAST® MIGHTY BLENDER with an empty vessel, as this may cause damage to the motor.
- If the BEAST® MIGHTY BLENDER overheats, shut off the motor. To reset, power off the BEAST® MIGHTY BLENDER and let it cool down for approximately one hour before using again.
- **DO NOT** use the BEAST® MIGHTY BLENDER for anything other than its intended use.
- **DO NOT** use the BEAST® MIGHTY BLENDER outdoors.
- Wash Blending Vessels, the Mighty Blade, and other accessories on the top rack of the dishwasher only. **DO NOT** wash the Blender Base in the dishwasher.
- **DO NOT** remove the gasket from the Mighty Blade.
- **DO NOT** remove the trademark/s, serial numbers, or bar codes from the BEAST® MIGHTY BLENDER.
- **DO NOT** use the BEAST® MIGHTY BLENDER with a voltage or electricity converter.
- **DO NOT** modify the BEAST® MIGHTY BLENDER in any way.
- This appliance has important markings on the plug blade. The attachment plug or entire cordset (if plug is molded onto cord) is not suitable for replacement. If damaged, the appliance should be replaced.

**SAVE THESE INSTRUCTIONS**

# What's Included

## Parts Included With B85:

1. B85 Blender Base
- 1a. Standby Switch on Blender Base
- 1b. Power Switch on Blender Base
- 1c. Power Cord on Blender Base
2. Beast Mighty Blade
3. 786mL Blending Vessel
4. 415mL Blending Vessel
5. 638mL Blending Vessel
6. 2 Storage Lids
7. Drinking Lid
8. Carry Cap
9. 2 Straws
10. Straw Cap
11. Straw Cleaning Brush
12. Blade Cleaning Brush

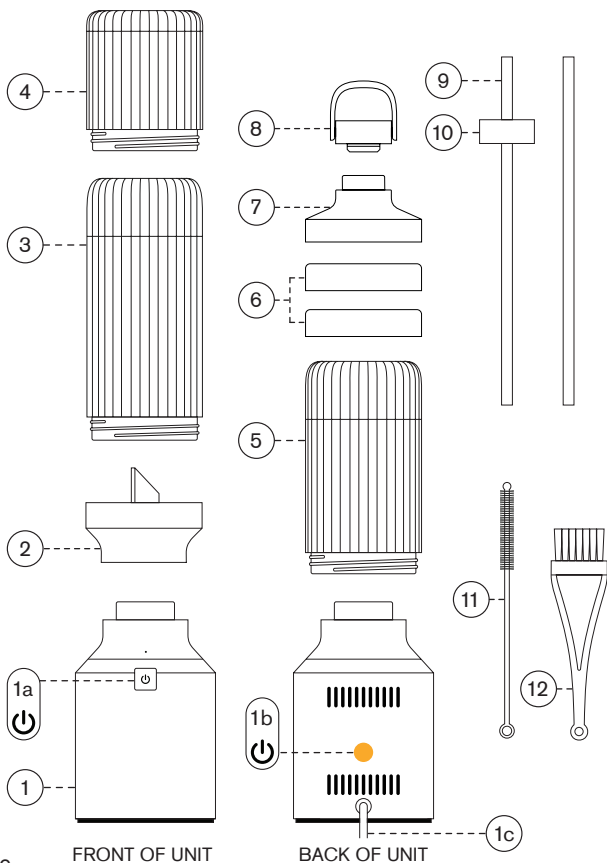

# Before Use

**Before using the product for the first time, disassemble and wash as follows:**

1. Remove the Mighty Blade (2) from the Blending Vessel (3) by turning the Mighty Blade (2) counter-clockwise.

**CAUTION:** Use caution when handling the Mighty Blade, as blades are extremely sharp.

2. Hand wash all parts except the B85 Blender Base (1) and Power Cord (1c) in warm, soapy water. Use your Blade Brush (6) to clean around the gasket of the Mighty Blade (2). Rinse and dry thoroughly.

**NOTICE:** Do not immerse the B85 Blender Base (1) or Power cord (1c) in water or other liquids. Do not place the Blender Base into a dishwasher or extremely hot water. Do not use abrasive cleaners to clean any part of the product.

## Max Fill Lines for Blending

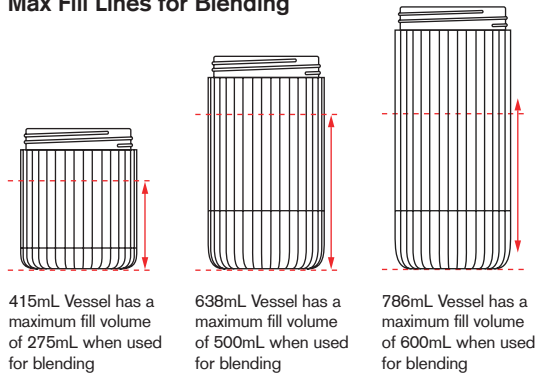

# B85 Blender Light Indicators

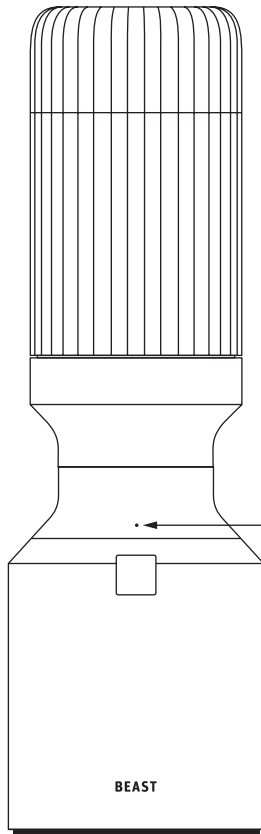

# B85 Blender Light Indicators

LED BEHAVIOR	MEANING
● Light Off	Unit Off
☀ Amber - Solid	Unit On, No Blade and/or Vessel Connected
☀ White - Solid	Unit On, Ready to Blend
☀ Green - Solid	Unit On, Blending In Progress

# How to Use Your B85 Blender

1. Plug the B85 Blender Base into a standard 120-volt AC electrical outlet.
2. Press the power switch at rear of Blender Base to turn ON power to the Blender Base.
3. Fill the Blending Vessel with food contents. Chop any large ingredients into small pieces to help prevent overloading the motor. Your Blending Vessel should contain at least  $\frac{1}{3}$  liquid for best results.
4. Attach the Mighty Blade to the Blending Vessel by turning the Mighty Blade clockwise until firmly secured to the Blending Vessel.
5. Mount the Blending Vessel with Mighty Blade onto the Blender Base by twisting clockwise until the Mighty Blade clicks into place.
6. Press the Standby Switch for  $>1$  second to begin 1-minute timed blend cycle.
7. Press the Standby Button for  $<1$  second to pulse the blades. Repeat until desired consistency is achieved.
8. Unmount the Blending Vessel with Mighty Blade from the Blender Base by twisting counter-clockwise.

The 1-minute timed blend cycle is intelligently programmed to efficiently blend your ingredients. It works as follows:

1. Blends for 20 seconds
2. Briefly slows down to allow ingredients to settle
3. Continues blending for 25 seconds
4. Briefly slows down to allow the ingredients to settle
5. Continues blending for 15 seconds
6. Stops after 1 full minute

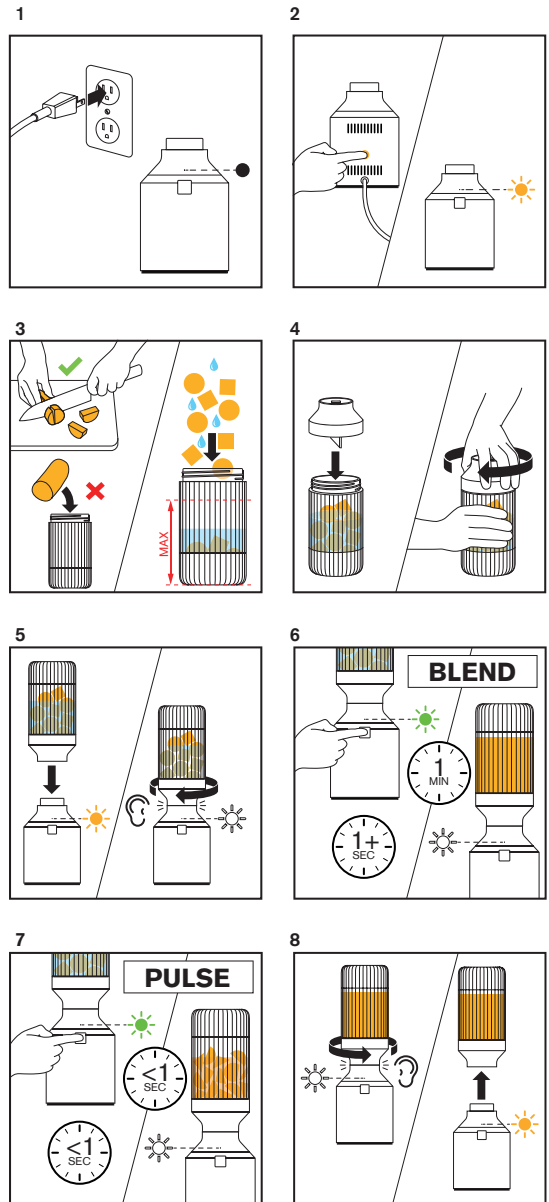

INSTRUCTIONS CONTINUE ON NEXT PAGE

CONTINUED ON NEXT PAGE



# How to Use Your B85 Blender

9. Remove the Mighty Blade from the Blending Vessel by turning the Mighty Blade counter-clockwise until the Mighty Blade can be removed.
10. Press the Power Switch at rear of Blender Base to turn OFF power to the unit.
11. Drink blend directly from the Blending Vessel, add the Vessel Drinking Lid and Carry Cap to take your blend on-the-go, or use the Storage Lid to blend for later in the refrigerator.

To clean all parts after each use, follow the below steps.

12. After each use, rinse your Mighty Blade under hot water. Use the Blade Cleaning Brush (included) to remove particles of food in and around the blade area, as well as in the cavity thread area above the gasket and clean with soap and water. If preferred, after each use, place Mighty Blade on the top rack of the dishwasher only. Allow Mighty Blade to completely dry before re-assembling your Beast Blender.
13. Rinse the Blending Vessels and clean with a kitchen dish brush, or the Beast Cleaning Brush (not included). If preferred, place Blending Vessels and Drinking Lids + Carry Caps on the top rack of the dishwasher only.
14. Clean Blender Base periodically with a damp towel or sponge.

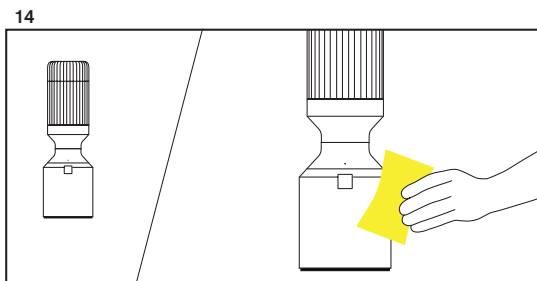
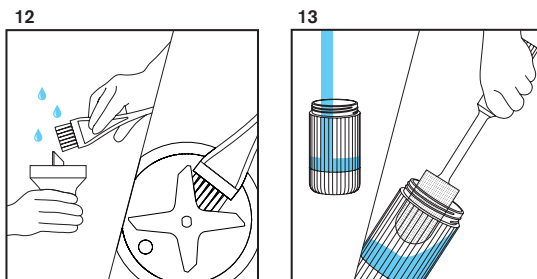
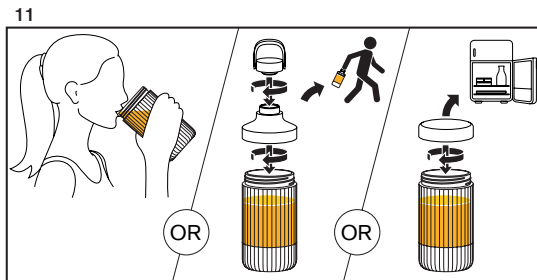
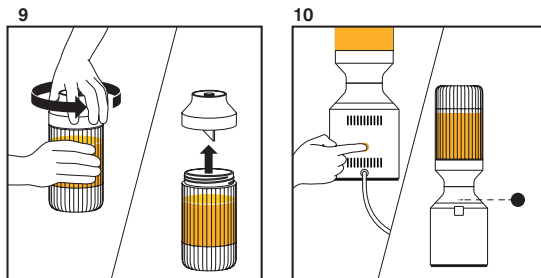

# Vessel Fill Example Chart

The below chart provides examples of ingredient types, amounts, and time required to blend/grind in each vessel.

	TYPE LOAD	ATTACHMENT	CAPACITY	BLENDE CYCLE
<b>BLENDED</b>	Carrots + Water	786mL Blending Vessel (600mL Max Fill) with Mighty Blade	240g Carrots 360g Water	60s
<b>BLENDED</b>	Carrots + Water	638mL Blending Vessel (500mL Max Fill) with Mighty Blade	200g Carrots 300g Water	60s
<b>GRINDING</b>	Wheat, Rice, Corn	638mL Blending Vessel (500mL Max Fill) with Mighty Blade	350g	60s
<b>BLENDED</b>	Carrots + Water	415mL Blending Vessel (275mL Max Fill) with Mighty Blade	100g Carrots 150g Water	60s

## Max Fill Lines for Blending

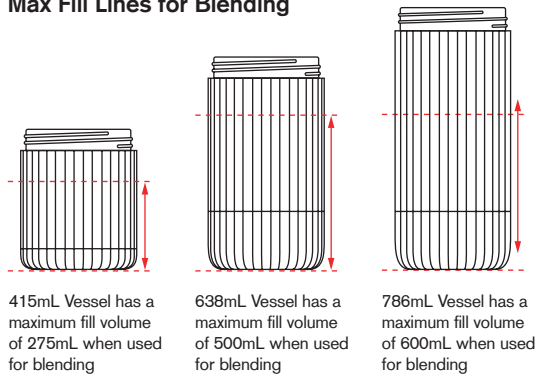

**PLEASE NOTE:** if your Blending Vessel is overfilled and the Mighty Blade is not screwed on tightly at the beginning of the blending cycle, your blend ingredients could spill into the threading and cause your Blending Vessel to get stuck to the Mighty Blade. This is why it is very important to follow the Max Fill Lines For Blending. However, if this does happen, refer to our FAQs for tips at [www.thebeast.com](http://www.thebeast.com).

# Tips & Tricks

## Shake Method to Loosen Stuck Ingredients

When blending tough foods, large ingredients, or with a limited amount of liquid in the vessel, the contents of the Blending Vessel may become stuck and require a manual method of freeing up the contents in order to continue blending.

1. Remove the Mighty Blade with Blending Vessel from the Blender Base.
2. With the Mighty Blade and Blending Vessel in hand, shake it up and down thoroughly.
3. Reattach to the Blender Base to finish blending.

## Coarsely Chop Ingredients by Pulsing

Pulsing is a useful way to coarsely chop ingredients without totally emulsifying them. This method is particularly useful for grinding coffee beans, making chunky salsa, chopping onions, and adding chunks of ingredients to an already smooth mixture for texture.

1. Press the Standby Switch on the front of the unit for less than 1 second.
2. Repeat until you achieve your desired texture.

## Loosen Vessel from Blade after Overfilling Ingredients

If the Blending Vessel is overfilled and the Mighty Blade is not screwed on tightly at the beginning of the blending cycle, the ingredients can spill into the threading, causing the two parts to seem like they are stuck, even though they are not. Your Blending Vessel has a max fill line - as a reminder, **ONLY** fill your ingredients to that line.

In these cases where the Blending Vessel has been overfilled past the max line, and the Mighty Blade + Vessel have become stuck, we recommend that you purchase and use your Beast Wrench to dislodge and/or unscrew the Vessel from the Mighty Blade. Purchase at [thebeast.com](http://thebeast.com).

1. Place your Vessel (with stuck Mighty Blade) firmly on the countertop and insert the Beast Wrench into its natural place in the Mighty Blade.
2. Carefully, with the Blending Vessel and Mighty Blade pointed away from your face and body, slowly twist the Wrench slightly to loosen the Mighty Blade, and then proceed to grip the Mighty Blade to carefully unscrew

**TIPS & TRICKS CONTINUE ON NEXT PAGE**

## Tips & Tricks

the Blade from the Blending Vessel. Note: this step should be conducted methodically and extremely carefully.

If you are unable to unscrew your Mighty Blade from your Vessel, we recommend that you purchase a new Blending Vessel and Mighty Blade.

## Troubleshooting

Please refer to the “B85 LED Light Behavior” section on page 11.

- If the LED light indicator displays:  
**No Visible Light**



**That Means:** Your blender unit is not powered on.

**Try:** Make sure that the Blender Base is plugged into a functioning standard 120-volt AC electrical outlet. Then power ON the unit by pressing the Power Switch at the back of the unit.

- If the LED light indicator displays:  
**Solid Amber Color Light**



**That Means:** Your blender unit is powered on, but the Mighty Blade and/or Blending Vessel is not properly connected.

**Try:** Confirm that the Mighty Blade is firmly threaded onto the Blending Vessel. Then confirm that the Mighty Blade and Blending Vessel are twisted onto the base until it clicks into place and the LED indicator displays a Solid White color light.

- If the LED light indicator displays:  
**Solid Green Color Light and does not blend**



**That Means:** The motor is overloaded.

**Try:** Power OFF the unit by pressing the Power Switch on the back of the unit. Wait 30 seconds for the unit to reset.

**Then:**

1. If the contents of the Blending Vessel appear to be stuck in place, perform the “Shake Method” listed in the “Tips & Tricks” section to free up the ingredients before continuing blending.

## Troubleshooting

2. If the Blending Vessel is filled beyond the Max Fill line, remove the Mighty Blade from the Blending Vessel. Remove enough contents to bring the fill level down to or below the Max Fill line. Then go to step 4 of the “How to Use Your B85 Blender” section to continue blending.
  3. If the LED light indicator continues to display a Green light, but does not blend, the motor itself may be overheated and will require time to cool down. Power OFF the unit, and allow to cool for one hour before attempting to blend again.
- If your Beast Blender motor sounds like it is laboring and blending is not efficient that means: Your Blending Vessel may be overfilled, or Blending Vessel contents may be stuck.

**Try:**

1. If the contents of the Blending Vessel appear to be stuck in place, perform the “Shake Method” listed in the “Tips & Tricks” section to free up the ingredients before continuing blending.
2. If the Blending Vessel is filled beyond the Max Fill line, remove the Mighty Blade from the Blending Vessel. Remove enough contents to bring the fill level down to or below the Max Fill line. Then go to step 4 of the “How to Use Your B85 Blender” section to continue blending.

## Beast Mighty Blade

The Beast Mighty Blade is unlike any other personal performance blade on the market. It is crafted from Grade 301 Stainless Steel, and other premium materials - rather than just plastic. The Beast Mighty Blade is safe and intelligent: our industry-leading interlock system confirms that the Blending Vessel, Mighty Blade, and Blender Base are all securely connected before it will begin blending.

In your hands, you have a Beast.

In order to keep your revolutionary Mighty Blade in top shape, it is important that you follow our care and cleaning tips.

After each use, rinse your Mighty Blade under hot water. Use the Blade Cleaning Brush (included) to remove particles of food in and around the blade area, as well as in the cavity thread area above the gasket and clean with soap and water. If preferred, after each use, place Mighty Blade on the top rack of the dishwasher only. Allow Mighty Blade to completely dry before re-assembling your Beast Blender.

If you use your Beast Blender more than three times per week (which we highly recommend), we suggest replacing your Mighty Blade and/or Blending Vessels every 6-12 months.

For a step-by-step guide on how best to take care of and clean your Beast Blender, scan the code below.



## Care + Cleaning

**CAUTION:** Always ensure the product is unplugged from the electrical outlet before relocating, assembling, disassembling, or cleaning it.

- Clean the product (as instructed under the “Before Use” section) immediately after each use.
- Use the Blade Cleaning Brush to remove particles of food lodged underneath the blades.
- Store the product in a cool, dry place.
- Never remove the gasket from the Beast Mighty Blade.
- Rinse the Blending Vessels and clean with the Beast Cleaning Brush (if included). If preferred, place Blending Vessels and Drinking Lids + Carry Caps on the top rack of the dishwasher only.
- Clean Blender Base periodically with a damp towel or sponge.

**PLEASE NOTE:** The white colored components are susceptible to staining, and should not come in direct contact with ingredients prone to causing stains, such as: turmeric, beets, carrots, or other bright colored ingredients. If these ingredients do come in contact with light-colored components, immediately follow the cleaning instructions listed below.

- Rinse the Cloud White accessories under tap water using a soapy brush or sponge to clean.
- For a deeper wash, follow the cleaning tips above.
- If your Blending Vessel is left for a prolonged period of time submerged with any of these ingredients, we recommend scrubbing the stained area with bleach and allow it to sit overnight.

## Care + Cleaning

**PLEASE NOTE:** The Tritan™ Blending Vessels are susceptible to staining and should not come in direct contact with turmeric. If turmeric does come in contact with your Blending Vessel, we kindly recommend to immediately follow these cleaning instructions:

- Fill the Blending Vessel with 1/2 Vinegar & 1/2 Water and allow to soak for 24 hours.
- Allow the stained vessel to sit outside exposed to the sunlight for an additional 24 hours, this will help with staining issues.

For any other care questions, email us at [help@thebeast.com](mailto:help@thebeast.com).

## Warranty

### **BEAST® BLENDER 2-YEAR LIMITED WARRANTY**

This limited warranty applies to authentic Beast® Blenders purchased from Beast Health, LLC or its authorized sellers and used by consumers in the United States and Canada. Your genuine Beast® Blender is warranted to be free from defects in material and workmanship for a period of two (2) years from its date of original purchase in the USA or Canada. This warranty is provided with your product at no additional charge. This warranty applies to the original product purchaser and is nontransferable. Proof of purchase must be provided with any warranty claim. This limited warranty applies to household use only and some additional exclusions and limitations apply. If a defect exists in your product and is subject to this limited warranty, at our sole discretion and option, we will either repair the product with new or refurbished parts, or replace the product or any component found to be defective. You are responsible for all shipping and processing costs associated with returning the product to us and for our return of a replacement, product, or component to you under this warranty. If a new or refurbished product or component is no longer available, we will replace it with a similar Beast Blender of equal or greater value, or reimburse the purchase price, at our option. This limited warranty is void and invalid if the unit has been damaged or fails due to: (i) accident, abuse, misuse or negligent operation; (ii) modification or alteration; (iii) improper care or maintenance; (iv) unauthorized third-party repairs or tampering; (v) product exposure to extreme or abnormal conditions, including natural disasters and acts of God; or, (vi) operation with a voltage converter or adaptor. This limited warranty excludes damage or failure resulting from normal wear and tear. This limited warranty extends to consumer use only and is void if the product has been utilized in a commercial or institutional setting.

**THIS LIMITED WARRANTY, AND THE REMEDIES SET FORTH HEREIN, ARE EXCLUSIVE AND PROVIDED IN LIEU OF ALL OTHER WARRANTIES, REMEDIES AND CONDITIONS, WHETHER ORAL OR WRITTEN, EXPRESS OR IMPLIED. BEAST HEALTH, LLC SPECIFICALLY DISCLAIMS ANY AND ALL IMPLIED WARRANTIES, INCLUDING, WITHOUT LIMITATION, WARRANTIES OF MERCHANTABILITY AND FITNESS FOR A PARTICULAR PURPOSE. BEAST HEALTH IS NOT RESPONSIBLE FOR ANY DIRECT, SPECIAL, INCIDENTAL OR CONSEQUENTIAL DAMAGES RESULTING FROM ANY ALLEGED BREACH OF WARRANTY OR CONDITION. IF BEAST HEALTH CANNOT LAWFULLY DISCLAIM IMPLIED WARRANTIES UNDER APPLICABLE STATE OR PROVINCIAL LAW, ANY REMAINING**

# Warranty

**WARRANTY, INCLUDING WARRANTIES OF MERCHANTABILITY AND FITNESS FOR A PARTICULAR PURPOSE, ARE LIMITED TO THE DURATION OF THIS LIMITED WARRANTY AND THE ORIGINAL PRODUCT PURCHASE PRICE.**

This warranty gives you specific legal rights and you may also have other legal rights that vary from State to State, Province to Province, depending upon where you live. Some States or Provinces do not allow limitations or exclusions on how long an implied warranty lasts or for the exclusion or limitation of special, incidental, or consequential damages, so the foregoing limitations or exclusions may not apply to you.

To make a warranty claim, do not return your product to its place of purchase, but instead, email us at [customerservice@thebeast.com](mailto:customerservice@thebeast.com), utilize the "Contact Us" link at <https://thebeast.com/pages/contact-us>, or write to Beast Health, LLC, Customer Service, 3019 Wilshire Blvd., Suite 279, Santa Monica, CA 90403 USA, with your warranty request. To expedite warranty processing, please provide the model, type, and serial number for your product, together with your name, address, telephone number, e-mail address, proof of original purchase (receipt) and description of the product issue or nonconformity, with your communication.

**strong inside™**



**strong inside™**



Designed in Los Angeles

[thebeast.com](https://thebeast.com)  
[thebeast.com/patents](https://thebeast.com/patents)

BEAST® is a registered trademark of Beast Health, LLC  
Copyright© 2024 Beast Health, LLC Los Angeles, CA 90272  
All rights reserved